

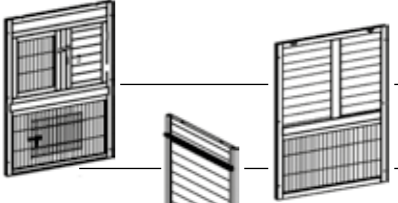

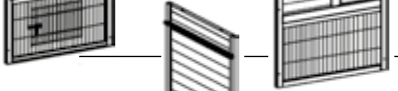

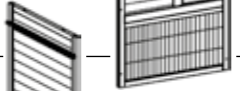

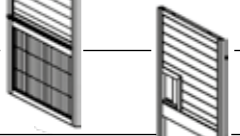













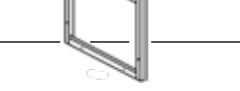





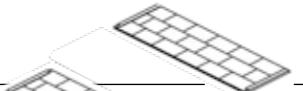
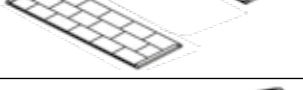
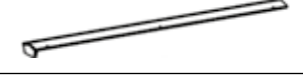

Pos.	Beschreibung Description	Maße Measurement	Anzahl Quantity	Art.-Nr. Item
1	Vorderteil für Stall Front part for hutch	 760 x 1160 x 25 mm	1	62332-10
2	Rückwand für Stall Back wall for hutch	 760 x 1160 x 25 mm	1	62332-20
3	Seitenteil für Stall, rechts Right side panel for hutch	 710 x 1160 x 25 mm	1	62332-31
4	Seitenteil für Stall, links Left side panel for hutch	 710 x 1160 x 25 mm	1	62332-30
5	Giebel für Stall, vorne Gable for hutch, front	 760 x 270 x 45 mm	1	62332-53
6	Giebel für Stall, hinten Gable for hutch, back	 760 x 270 x 45 mm	1	62332-61
7	Leiste für Stall, links Side batten for hutch, left	 710 x 55 x 15 mm	1	62332-52
8	Ausziehbare Bodenwanne Drawer with plastic inlay	 730 x 715 x 50 mm	1	62332-40
9	Trennwand Partition	 700 x 490 x 8 mm	1	62332-34
10	Mittelboden Mid-floor	 700 x 350 x 12 mm	2	62332-60
11	Linke Dachhälfte für Stall Roof part for hutch, left	 910 x 510 x 30 mm	1	62332-50
12	Rechte Dachhälfte für Stall Roof part for hutch, right	 910 x 510 x 38 mm	1	62332-51
13	Dachfirst für Stall Roof ridge for hutch	 940 x 90 x 60 mm	1	62332-54
14	Giebel für Freilauf, links/rechts Gable for enclosure, left/right	 760 x 170 x 45 mm	1/1	62332-57
15	Seitenteil für Freilauf, links Left side panel for enclosure	 710 x 770 x 25 mm	1	62332-32
16	Seitenteil für Freilauf, rechts Right side panel for enclosure	 710 x 770 x 25 mm	1	62332-33
17	Schutzprofil Protection profile	 650 x 55 x 10 mm	1	62332-35
18	Vorderteil für Freilauf Front part for enclosure	 1100 x 765 x 25 mm	1	62332-11
19	Rückwand für Freilauf Back wall for enclosure	 1100 x 765 x 25 mm	1	62332-21
20	Leisten für Freilauf, vorne/hinten Roof ledge for enclosure, front/back	 1150 x 60 x 15 mm	2	62332-58
21	Rampe Ramp	 1050 x 170 x 20 mm	1	62332-41

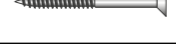
Pos.	Beschreibung Description	Maße Measurement	Anzahl Quantity	Art.-Nr. Item
22	Hintere Dachhälfte für Freilauf Roof for enclosure, back	 1140 x 460 x 20 mm	1	62332-56
23	Vordere Dachhälfte für Freilauf Roof for enclosure, front	 1140 x 460 x 20 mm	1	62332-55
24	Dachfirst für Freilauf Roof ridge for enclosure	 1170 x 100 x 60 mm	1	62332-59

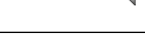
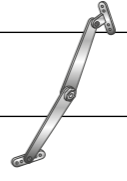
Pos.	Beschreibung Description	Größe Size	Anzahl Quantity	Art.-Nr. Item
A	Senkkopfschraube Countersunk screw	 ø 3,5 x 45	30+1	62332-65
B	Senkkopfschraube Countersunk screw	 ø 3,5 x 75	18+1	
C	Senkkopfschraube Countersunk screw	 ø 3,5 x 30	14+1	
D	Senkkopfschraube Countersunk screw	 ø 3,5 x 40	4+1	
E	Senkkopfschraube Countersunk screw	 ø 3 x 14	3+1	6235-61
F	Senkkopfschraube Countersunk screw	 ø 3,5 x 35	8+1	
G	Fangband Check strap	 plus je 8 Schrauben H plus 8 screws H for each	280 mm	1
H	Linsenkopfschraube Lenshead screw	 ø 4 x 16 mm	8+1	6235-56
I	Verschlussriegel Locking bolt	 plus je 1 Schraube J plus 1 screw J for each	70 mm	
J	Senkkopfschraube, schwarz Countersunk screw, black	 ø 3,0 x 25 mm	3	

Weitere bereits vormontierte Teile (als Ersatzteile separat erhältlich)  
Other parts already assembled (spare parts separately available)

Beschreibung Description	Größe Size	Anzahl Quantity	Art.-Nr. Item
Scharnier, für vordere Stalltür und obere Tür des Auslaufs Hinge, for front door of the hutch and the upper door of enclosure	5 cm	6	6235-72
Scharnier für untere Tür des Auslaufs Hinge for lower door of the enclosure	6,35 cm	2	6235-73
Scharnier für Dach des Stalls Hinge for roof of the hutch	7,6 cm	2	6235-74

- Ⓧ Sie finden eine französische und italienische Anleitung unter der jeweiligen Artikel-Nummer auf [www.trixie.de](http://www.trixie.de).
- Ⓞ Please find instructions in French and Italian under the corresponding item number at [www.trixie.de](http://www.trixie.de).
- ⓕ Vous trouverez les informations détaillées en français et en italien à chaque référence d'article, sur notre site [www.trixie.de](http://www.trixie.de).
- Ⓛ Le istruzioni in italiano e francese sono disponibili selezionando il codice dell'articolo sul nostro sito [www.trixie.de](http://www.trixie.de).

- ⓓ Montieren Sie zuerst den Stall: Verbinden Sie das Vorderteil (1) und die Rückwand (2) mit den Seitenteilen (3/4).
- Ⓞ First install the hutch: Connect the front part (1) and the back wall (2) with the side panels (3/4).

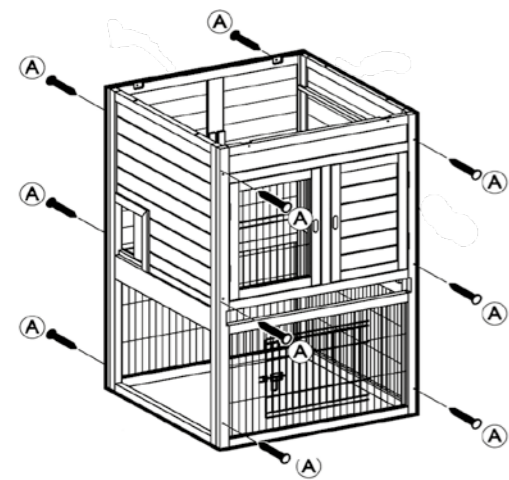

1.

- ⓓ Befestigen Sie nun den vorderen und hinteren Stallgiebel (5/6). Verschrauben Sie die linke Seitenleiste (7).
- Ⓞ Now fix the front and back panels of the gable (5/6). Screw also the left side battens (7) in tight.

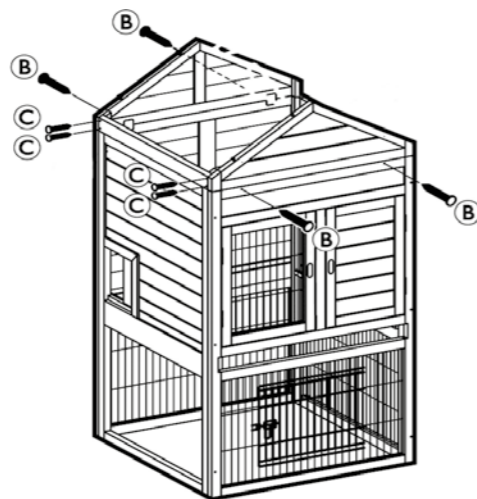

2.

- ⓓ Schieben Sie die ausziehbare Bodenwanne (8) und die Trennwand (9) ein. Danach legen Sie den Mittelboden (10) ein.
- Ⓞ Insert the drawer (8) and the partition (9) and then the mid-floor (10).

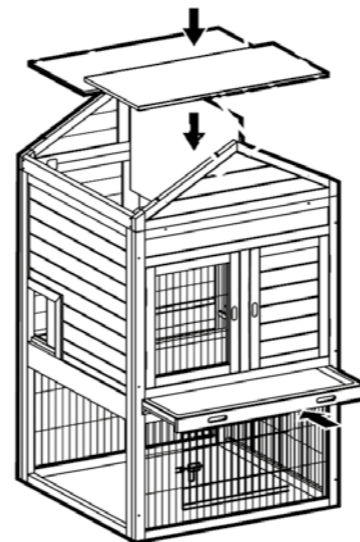

3.

- ⓓ Befestigen Sie die linke Dachhälfte (11). Montieren Sie danach die rechte Dachhälfte (12) und fixieren Sie das Fangband (G) an der Innenseite dieser Dachhälfte und an der Rückwand. Verschrauben Sie den Dachfirst (13).
- Ⓞ Fix the left part of the roof (11). Then mount the right part (12) and screw the check strap (G) at the inner side of this roof part and at the back wall. After that fix the ridge (13).

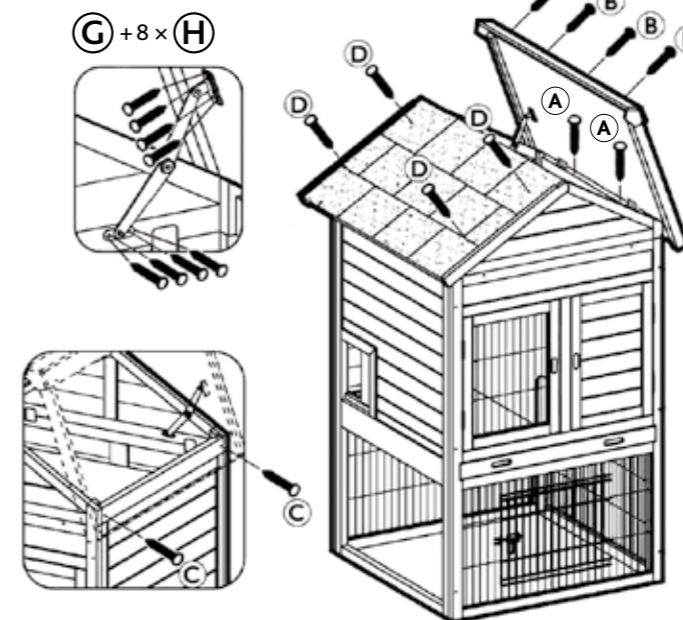

4.

- ⓓ Montieren Sie nun das Freilaufgehege: Zuerst verschrauben Sie den linken und rechten Giebel (14) mit den dazugehörigen Freilauf-Seitenteilen (15/16).
- Ⓞ Now install the enclosure: First screw the left and right panels of the gable (14) with the corresponding panels for the enclosure (15/16).

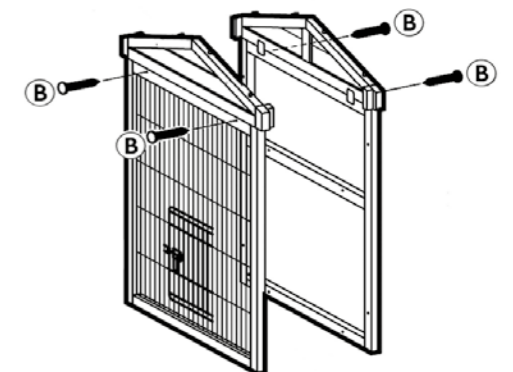

5.

- ⓓ Befestigen Sie dann das offene Seitenteil am Kleintierstall. Bevor Sie die beiden unteren Leisten verschrauben, legen Sie über diese das Schutzprofil (17).
- Ⓞ Fix the open side panel to the hutch. Before you screw the two lower battens together, put the protection profile (17) on it.

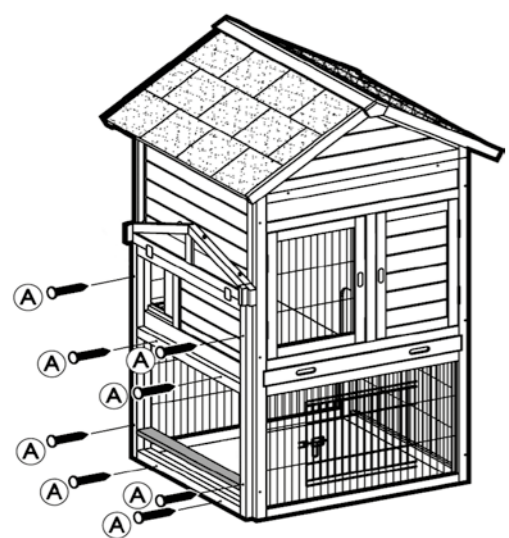

6.

- ⓓ Verbinden Sie nun das übrige Seitenteil (15), das Vorderteil (18) und die Rückwand des Freilaufgeheges (19) mit dem Kleintierstall. Die Enden der Giebel verbinden Sie mit den beiden Leisten (20). Befestigen Sie die Rampe (21) an der oberen seitlichen Öffnung des Stalles.
- Ⓞ Now connect the remaining side panel (15), the front part (18) and the backwall of the enclosure (19) to the hutch. Connect the sides of the gable with the two battens (20). Fix the ramp (21) at the upper side opening of the hutch.

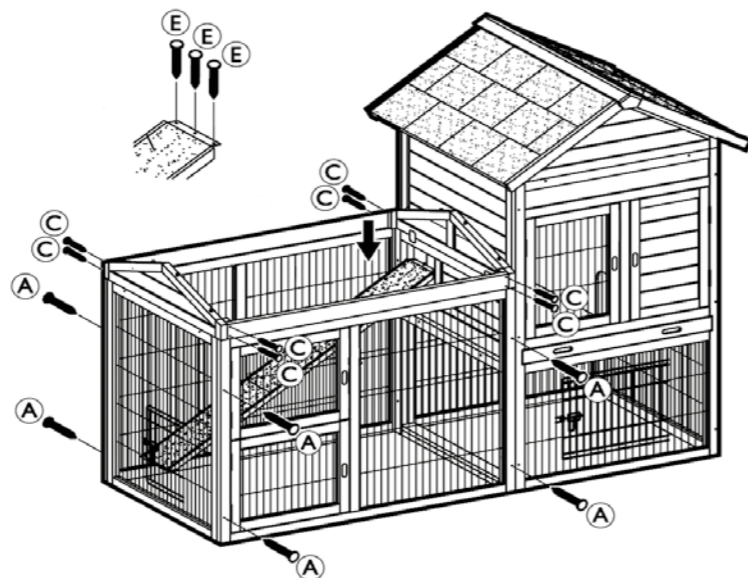

7.

- ⓓ Schrauben Sie nun die beiden Dachhälften (22/23) fest.
- Ⓞ Screw the two parts of the enclosure roof (22/23) in tight.

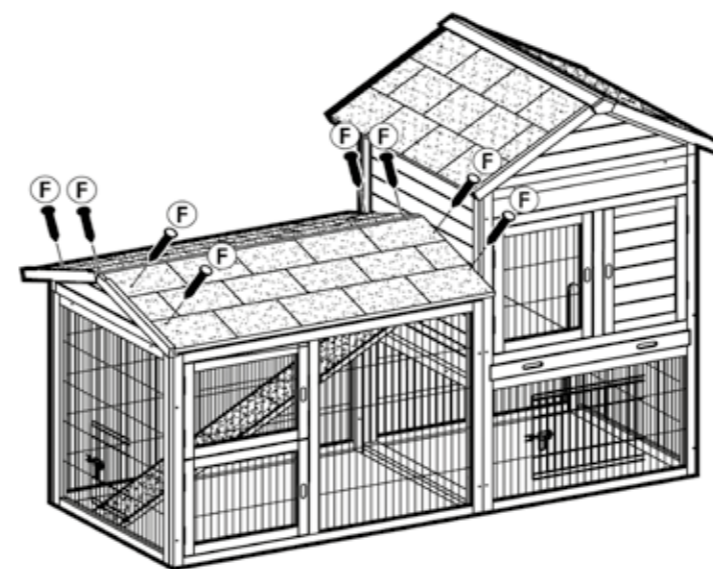

8.

- ⓓ Befestigen Sie danach den First (24) am Freilaufdach. Abschließend montieren Sie die drei Verschlussriegel (I).
- Ⓞ Fix the ridge (24) at the roof of the enclosure. At last mount the three locking bolts (I).

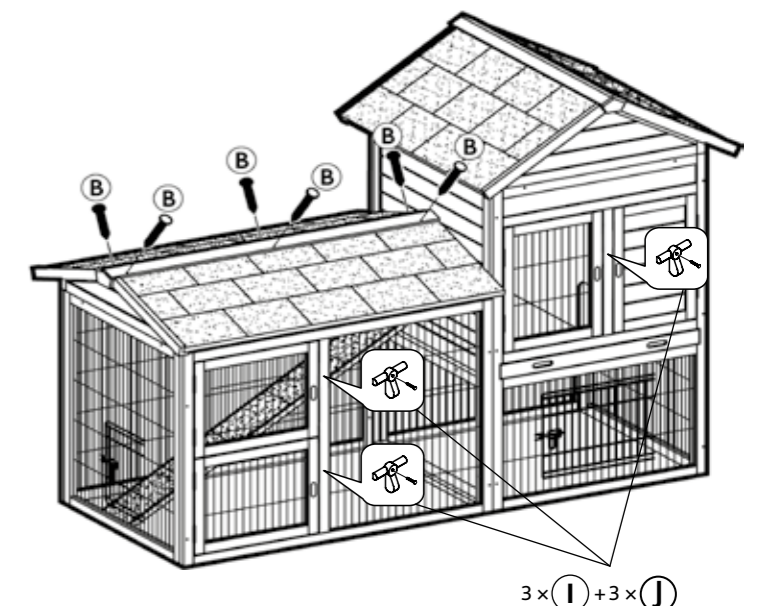

9.